

CONVENTIONAL TUB DETAILS  
SCALE: 1/8" = 1'-0"

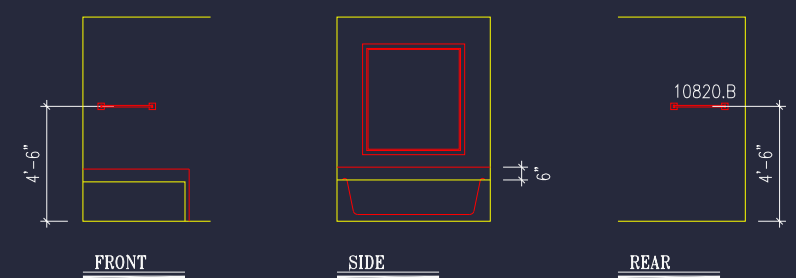

ULTRA BATH TUB DETAILS  
SCALE: 1/8" = 1'-0"

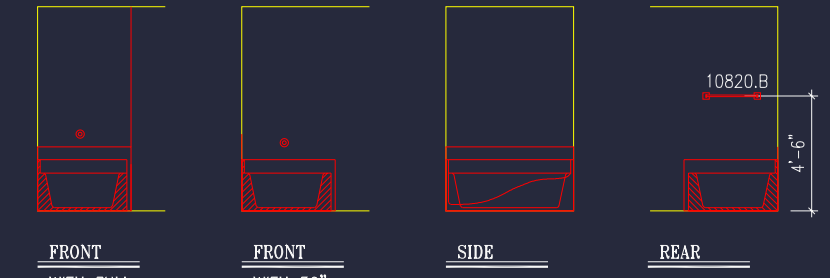

GARDEN TUB DETAILS (WITH SEPARATE SHOWER)  
SCALE: 1/8" = 1'-0"

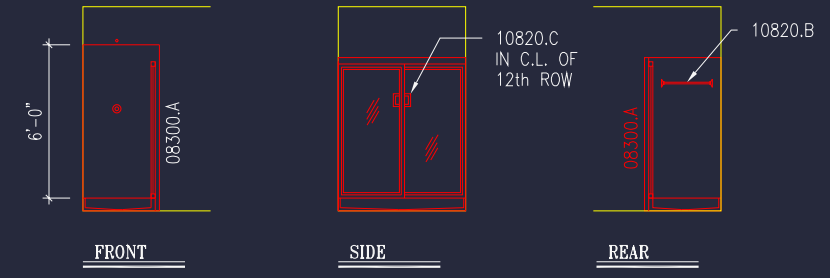

SHOWER DETAILS  
SCALE: 1/8" = 1'-0"

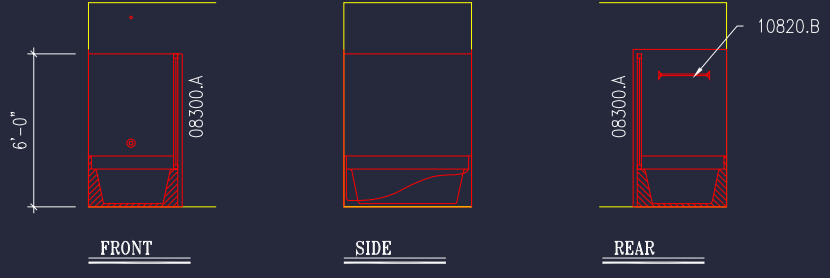

GARDEN TUB DETAILS (WITHOUT SEPARATE SHOWER)  
SCALE: 1/8" = 1'-0"

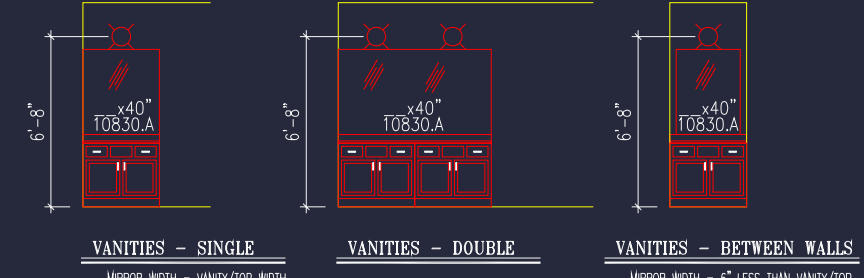

VANITY DETAILS  
SCALE: 1/8" = 1'-0"

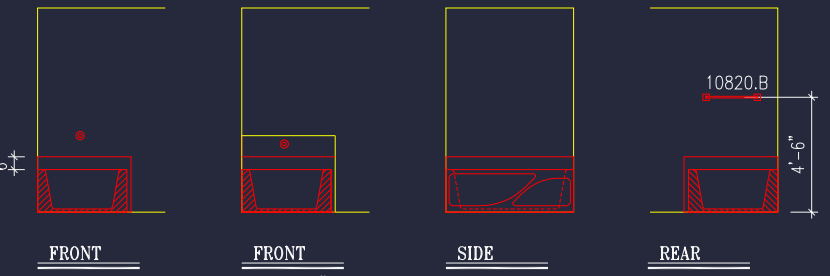

GARDEN TUB DETAILS (WITH WHIRLPOOL JETS OPTION)  
SCALE: 1/8" = 1'-0"

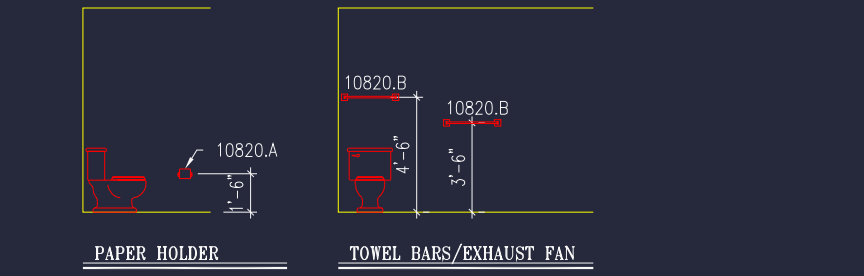

PAPER HOLDER/TOWEL BARS  
SCALE: 1/8" = 1'-0"

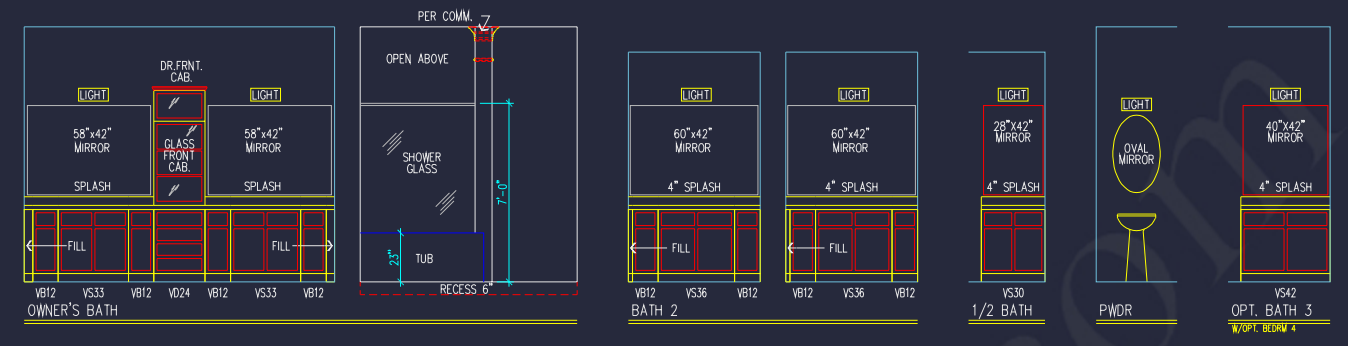

VIEW @ BATH #2

VIEW @ MASTER BATH

CABINET ELEVATIONS & CROSS SECTIONS  
SCALE: 1/4" = 1'-0"

NOTE: CABINET MAKER SHALL VERIFY ALL DIMENSIONS IN THE FIELD BEFORE CABINET CONSTRUCTION.

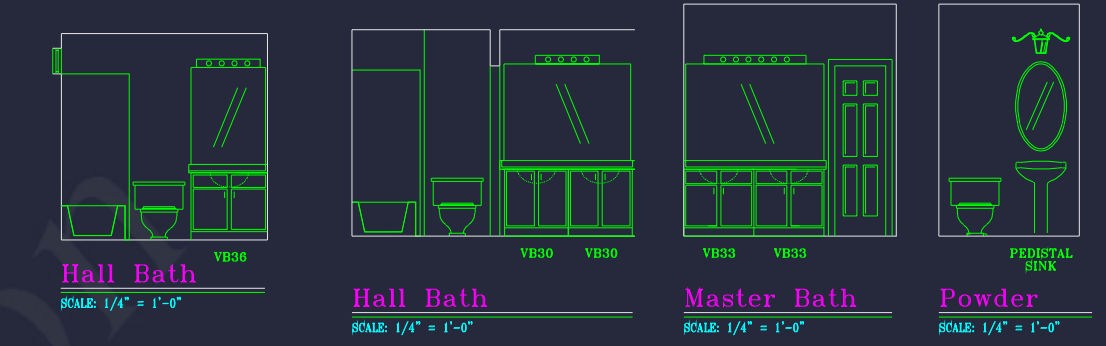

Hall Bath  
SCALE: 1/4" = 1'-0"

Master Bath  
SCALE: 1/4" = 1'-0"

Powder  
SCALE: 1/4" = 1'-0"

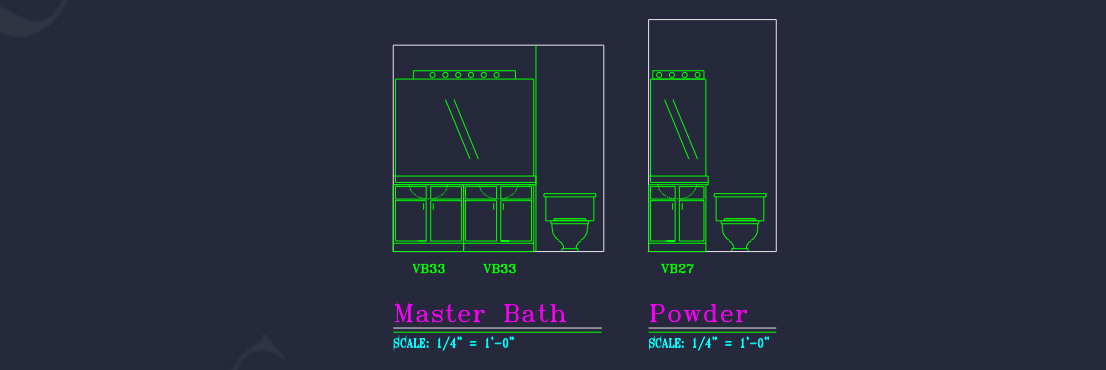

Master Bath  
SCALE: 1/4" = 1'-0"

Powder  
SCALE: 1/4" = 1'-0"

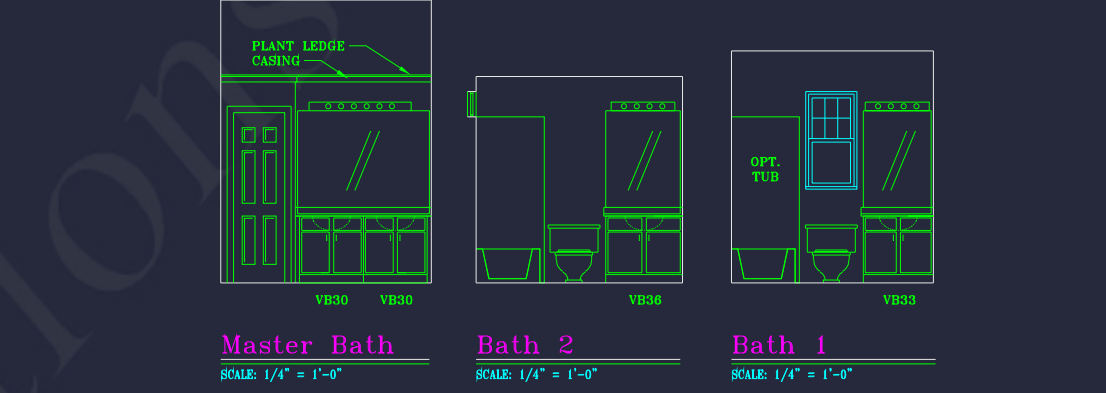

Master Bath  
SCALE: 1/4" = 1'-0"

Bath #2  
SCALE: 1/4" = 1'-0"

Bath #1  
SCALE: 1/4" = 1'-0"

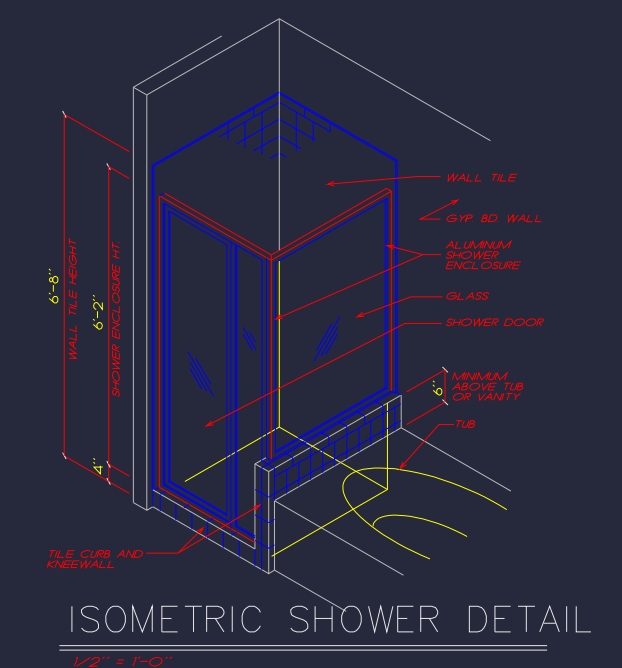

ISOMETRIC SHOWER DETAIL  
SCALE: 1/4" = 1'-0"

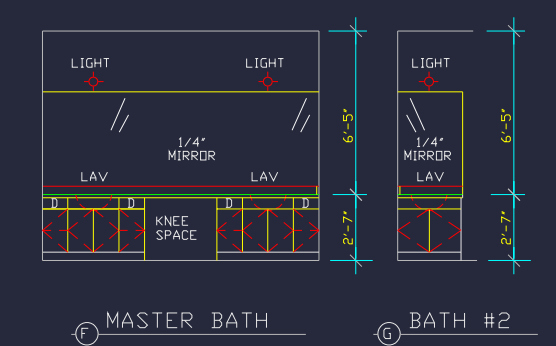

MASTER BATH

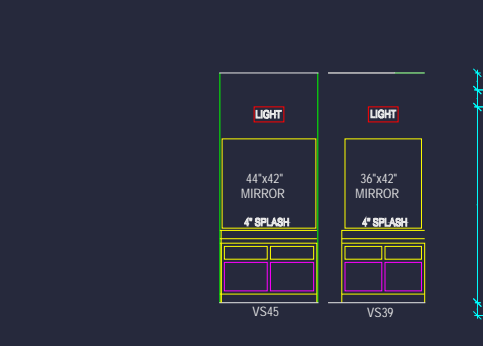

BATH #2

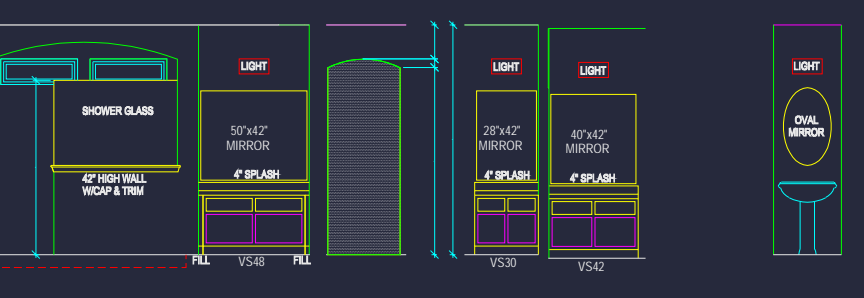

MASTER VANITY  
SCALE: 1/4" = 1'-0"

MASTER VANITY  
SCALE: 1/4" = 1'-0"



BATH #1 PLAN  
SCALE: 1/4" = 1'-0"

BATH #1  
SCALE: 1/4" = 1'-0"

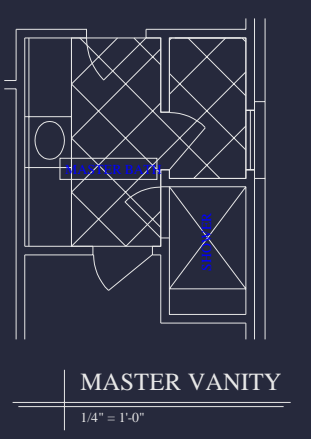

MASTER VANITY  
SCALE: 1/4" = 1'-0"

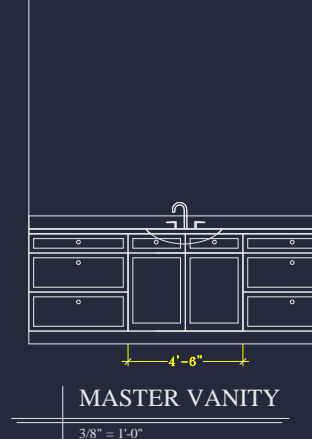

MASTER VANITY  
SCALE: 1/4" = 1'-0"

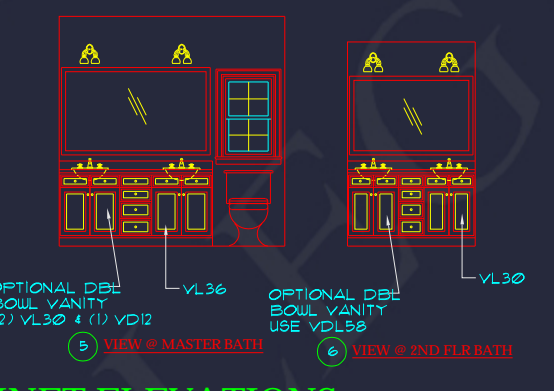

CABINET ELEVATIONS  
SCALE: 1/8" = 1'-0"

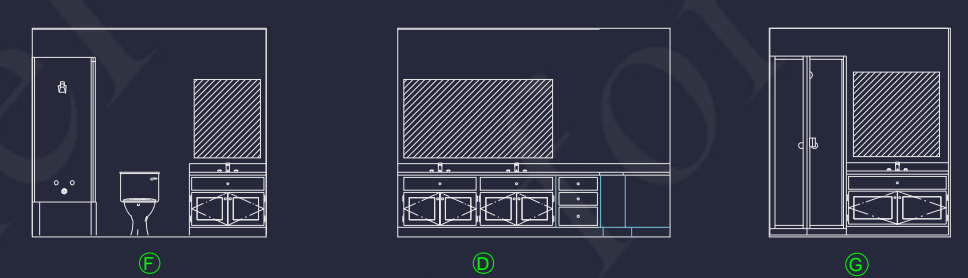

BATH ELEVATIONS  
SCALE: 1/4" = 1'-0"

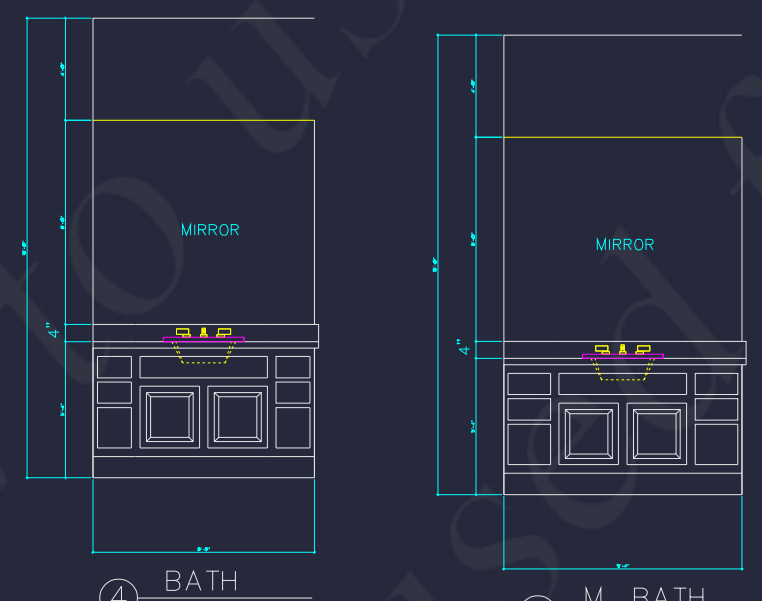

BATH  
SCALE: 1/4" = 1'-0"

M. BATH  
SCALE: 1/4" = 1'-0"

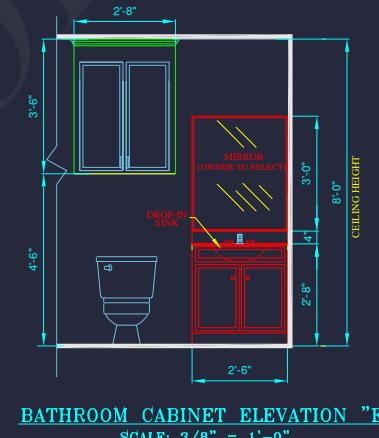

BATHROOM CABINET ELEVATION "B"  
SCALE: 3/8" = 1'-0"

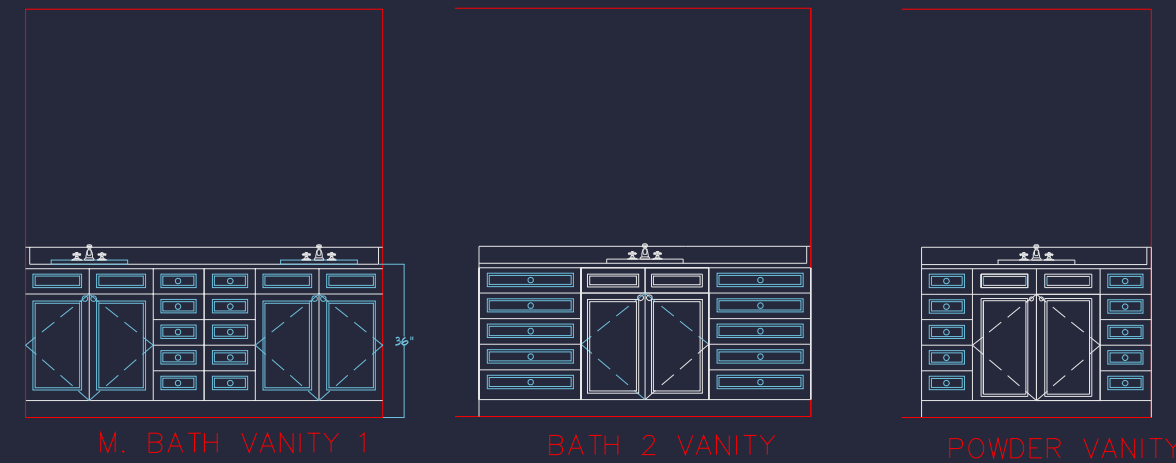

M. BATH VANITY 1

BATH 2 VANITY

POWDER VANITY

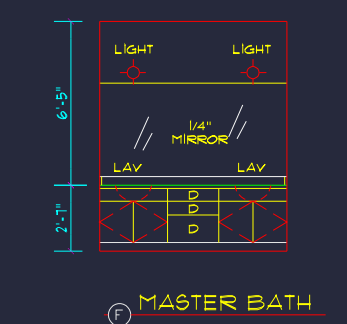

MASTER BATH

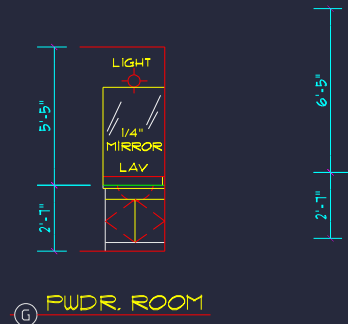

POWDR. ROOM

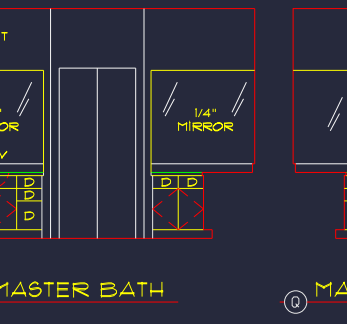

MASTER BATH

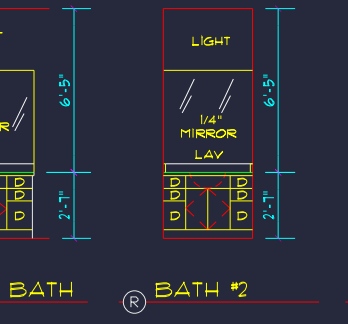

MASTER BATH

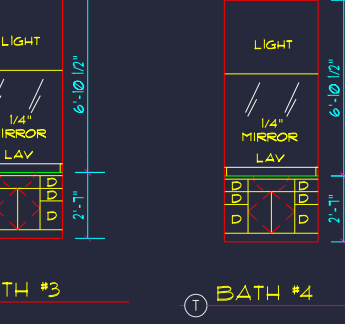

BATH #2



BATH #3



BATH #4

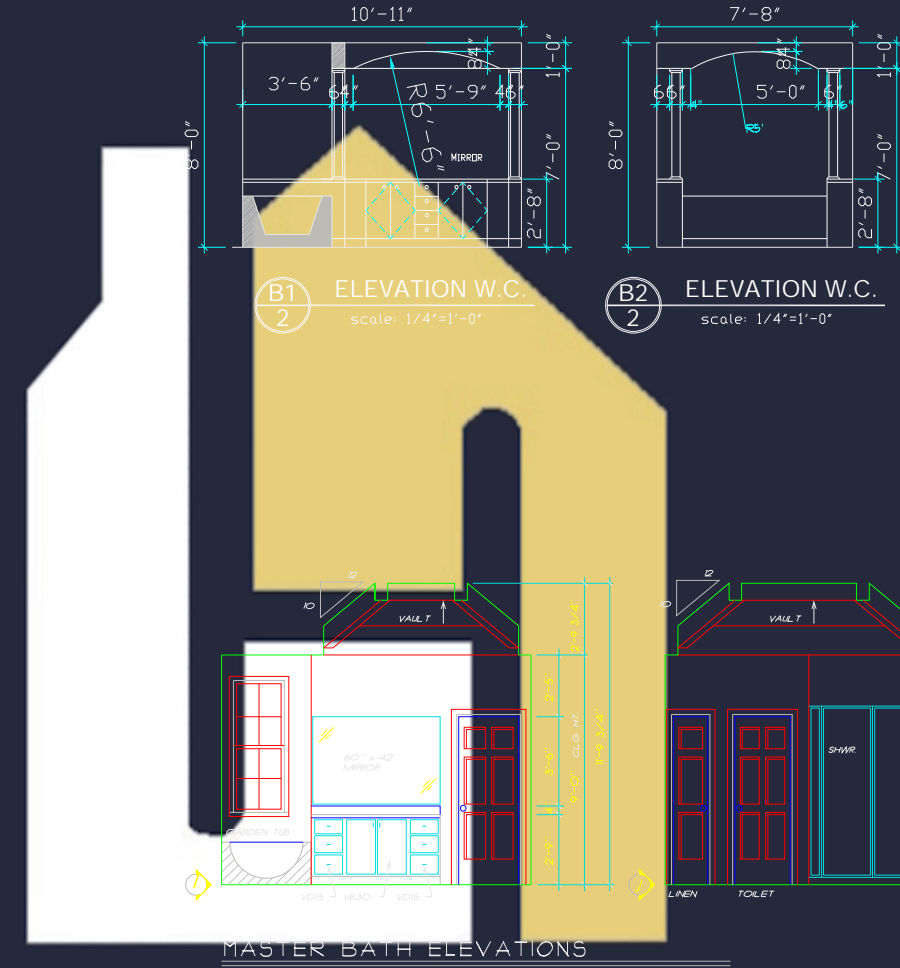

MASTER BATH ELEVATIONS

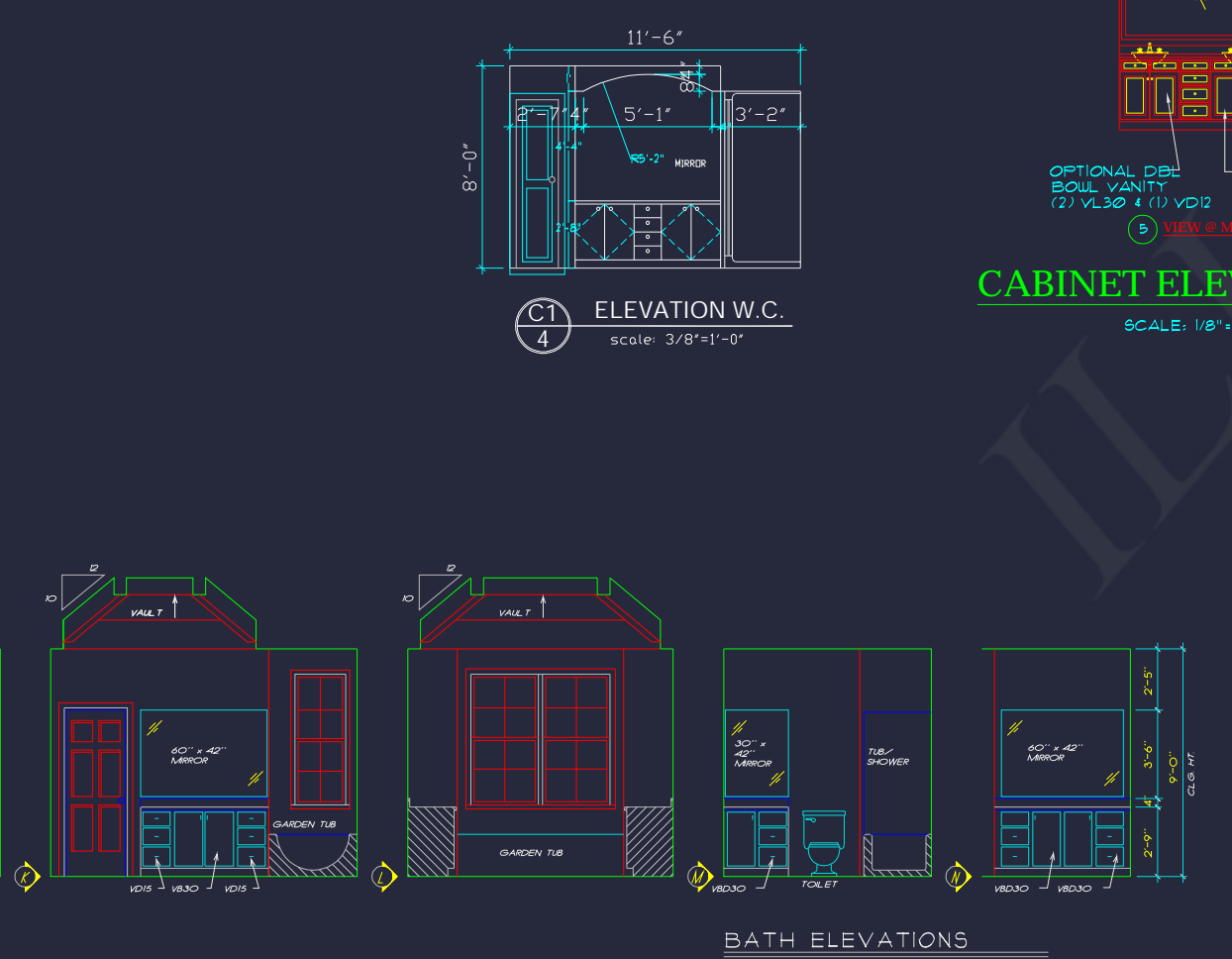

BATH ELEVATIONS

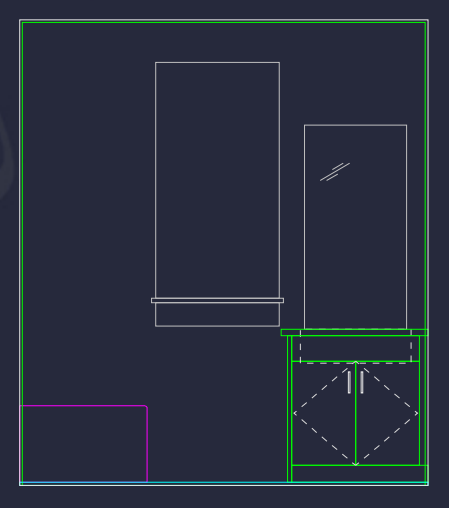

CHARLIE'S BATH  
(bedroom 2)

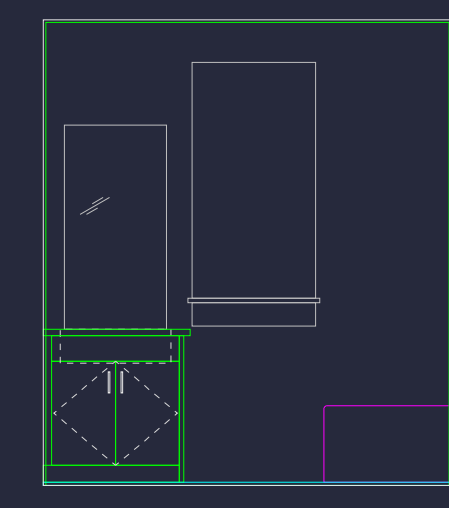

JAMES' BATH  
(bedroom 3)

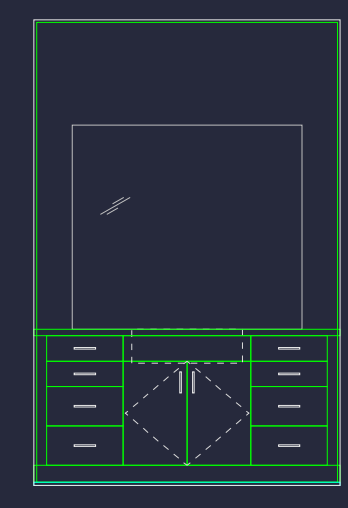

ELEANOR'S BATH

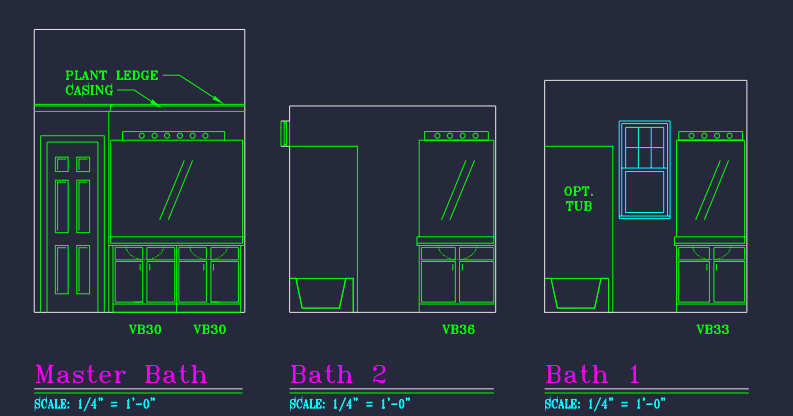

Master Bath  
SCALE: 1/4" = 1'-0"

Bath #2  
SCALE: 1/4" = 1'-0"

Bath #1  
SCALE: 1/4" = 1'-0"

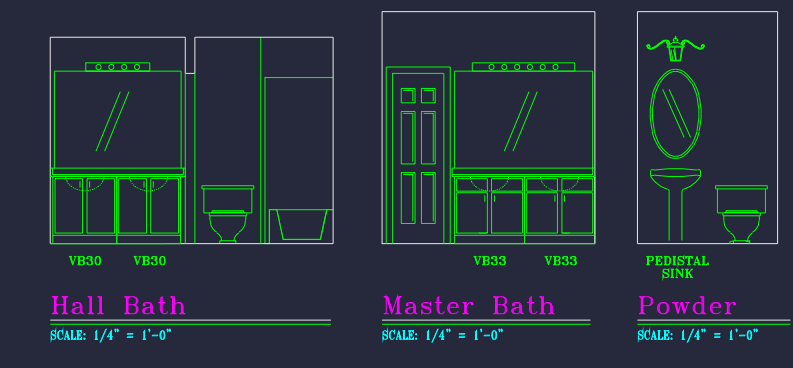

Hall Bath  
SCALE: 1/4" = 1'-0"

Master Bath  
SCALE: 1/4" = 1'-0"

Powder  
SCALE: 1/4" = 1'-0"