

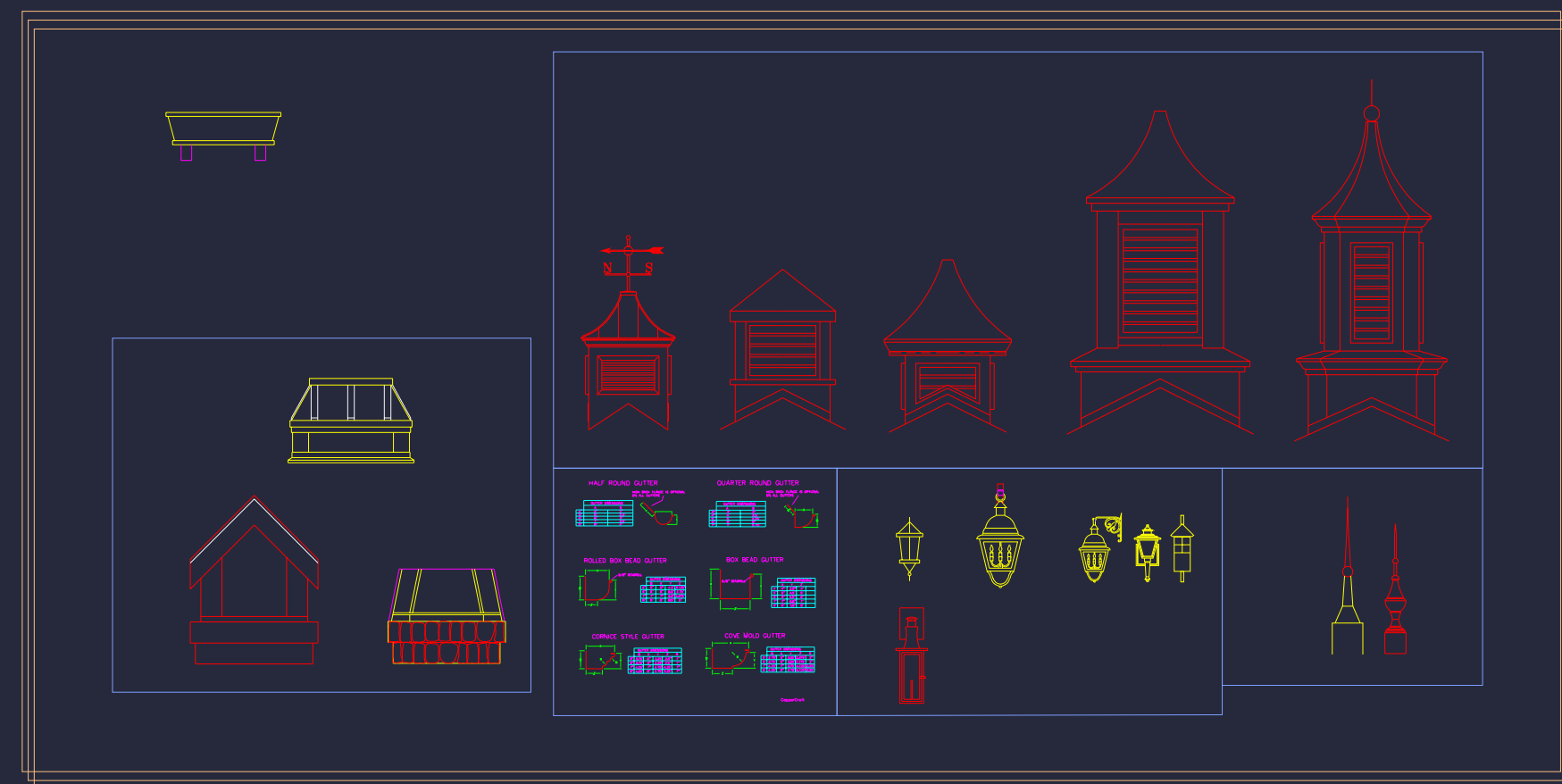

# MISC. EMBELLISHMENTS

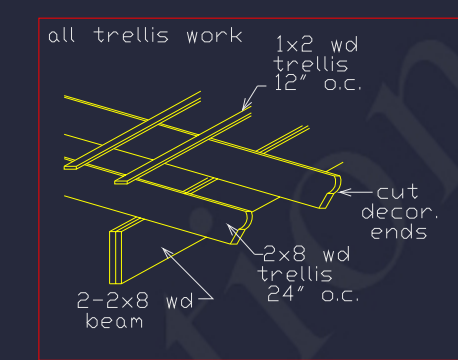

## DETAILS

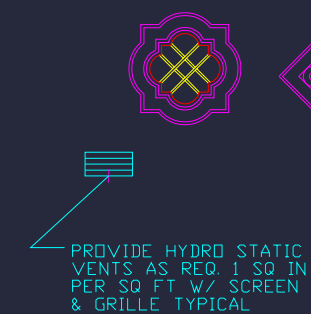

## CHIMNEYS

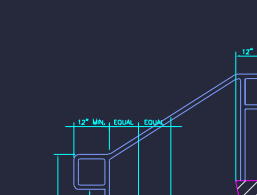
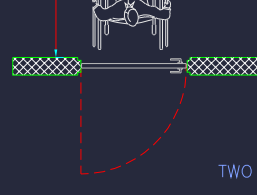
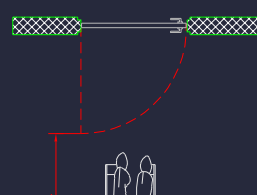
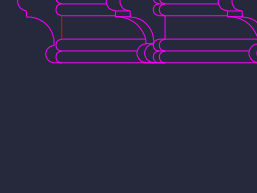
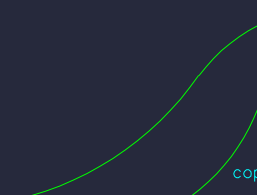
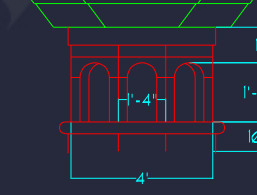
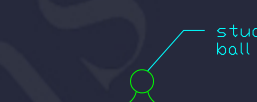
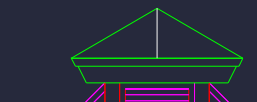
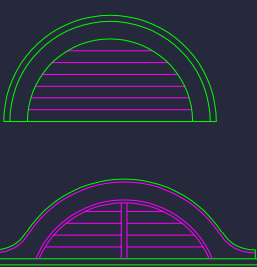
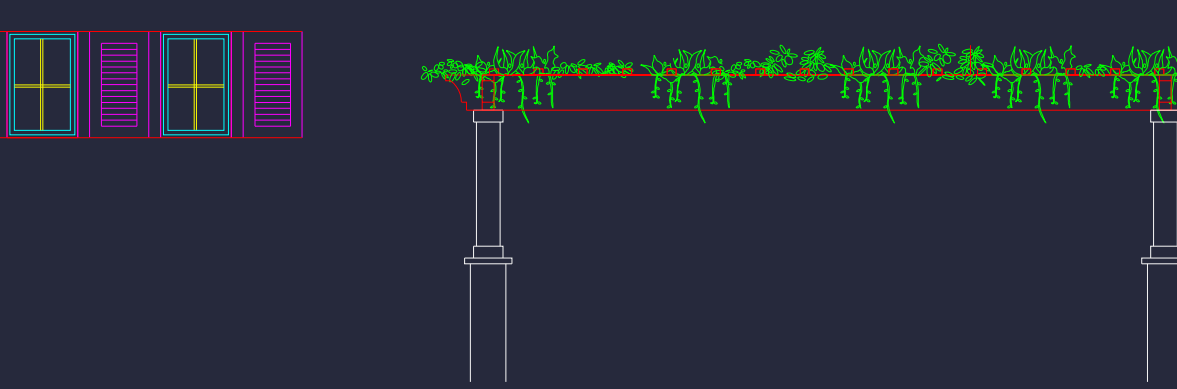
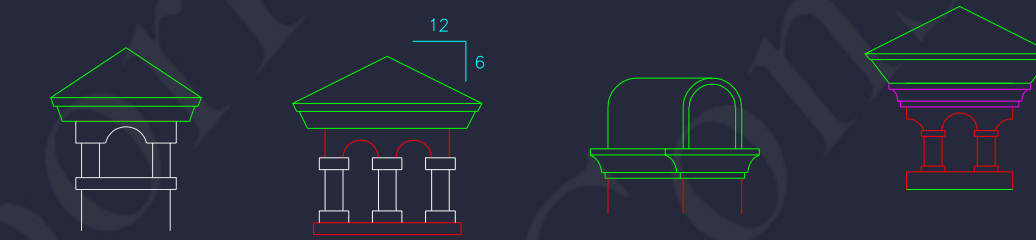

# SHUTTERS

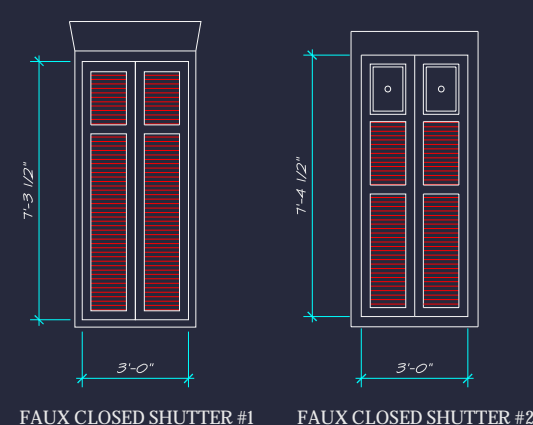
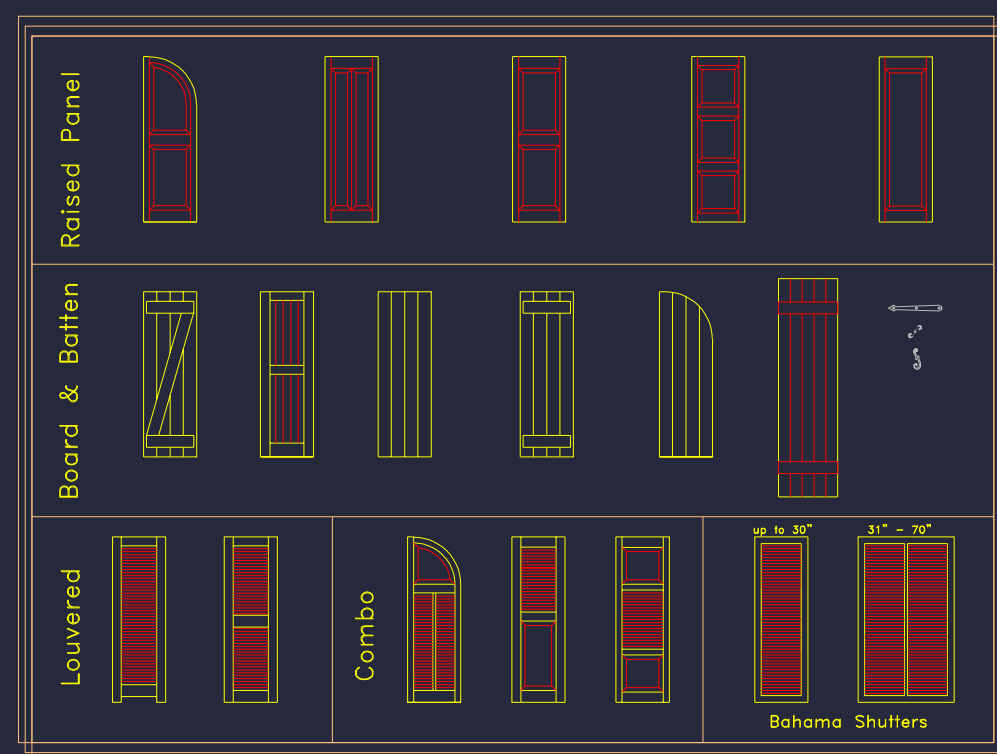

SHUTTER VENT #3

## SHUTTERS

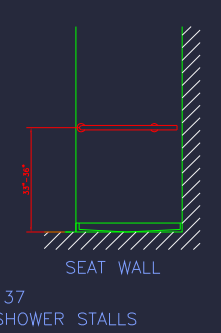
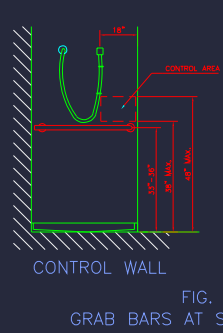
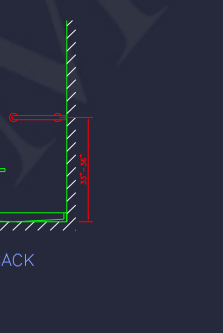
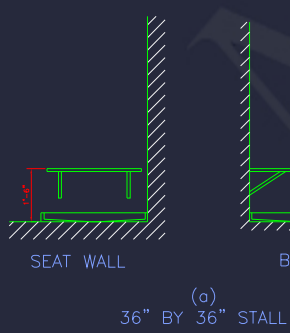
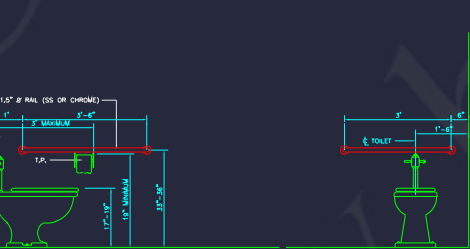
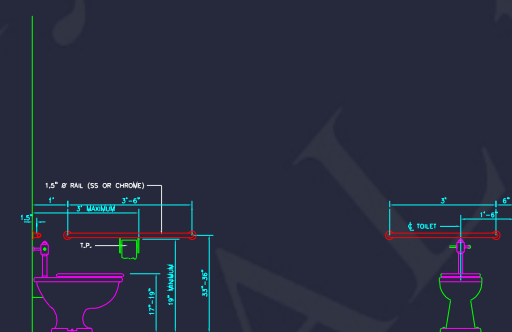
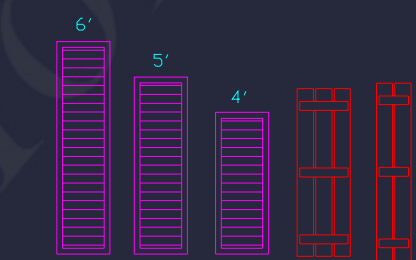

FIG. 37  
GRAB BARS AT SHOWER STALLS  
NOTE: SHOWERHEAD AND CONTROL AREA MAY BE ON BACK (LONG) WALL (AS SHOWN) OR ON EITHER SIDE WALL

